

Ultimate Short Throw LCD Projectors

HITACHI
Inspire the Next



• Projected image is a simulation.



ULTIMATE 究極 SHORT THROW

Large-screen projection even in small classrooms and meeting rooms

Ultimate Short Throw LCD Projectors

CP-AW252WN/CP-AW252WNM WXGA 2,500 Lumens

CP-A302WN/CP-A302WNM XGA 3,000 Lumens

CP-A222WN/CP-A222WNM XGA 2,200 Lumens

Ultimate Interactive Short Throw LCD Projectors

CP-AW2519N/CP-AW2519NM WXGA 2,500 Lumens

• Wall mount unit (HAS-K252): included with CP-AW252WNM/CP-A302WNM/CP-A222WNM.
• Wall mount unit (HAS-K250): included with CP-AW2519NM.
• CP-AW2519N/CP-AW2519NM are not compatible with Crestron RoomView®.



Ultimate Short Throw and Network functions make lessons easier to conduct and easier to understand



Ultimate Short Throw

■ Reduced Glare and Shadows

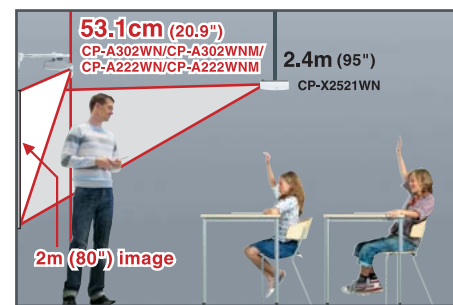

These projectors feature Ultimate Short Throw, for projecting a 2m (80 inches) image from only 53.1cm (20.9 inches)* onto a wall or whiteboard. Ultimate Short Throw greatly reduces glare from the projector's

light source, making it easier for the teacher or presenter to see the audience. The audience also has a clearer view because the teacher's or presenter's hands and body shadows are minimized. The result is a better classroom or meeting room experience for both teachers or presenters and audience.

* CP-A302WN/CP-A302WNN/CP-A222WN/CP-A222WNN.
CP-AW252WN/CP-AW252WNN/CP-AW2519N/CP-AW2519NM are 56.2cm (22.1 inches).

Projection Distance

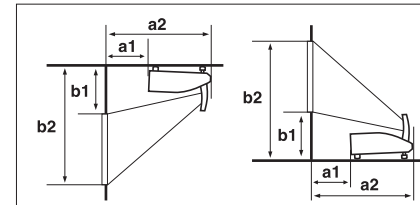

Screen Size (16:10 Screen)	CP-AW252WN/CP-AW252WNN/CP-AW2519N/CP-AW2519NM				CP-A302WN/CP-A302WNN/CP-A222WN/CP-A222WNN			
	a1	a2	b1	b2	a1	a2	b1	b2
60 type (inch), 1.5m	0.120m (4.7")	0.426m (16.8")	0.295m (11.6")	1.102m (43.4")	0.096m (3.8")	0.403m (15.9")	0.281m (11.1")	1.196m (47.1")
70 type (inch), 1.8m	0.188m (7.4")	0.494m (19.5")	0.332m (13.1")	1.274m (50.2")	0.161m (6.3")	0.467m (18.4")	0.317m (12.5")	1.384m (54.5")
80 type (inch), 2.0m	0.256m (10.1")	0.562m (22.1")	0.369m (14.5")	1.446m (56.9")	0.225m (8.9")	0.531m (20.9")	0.352m (13.9")	1.571m (61.9")
90 type (inch), 2.3m	0.324m (12.8")	0.631m (24.8")	0.407m (16.0")	1.618m (63.7")	0.289m (11.4")	0.596m (23.4")	0.387m (15.2")	1.759m (69.2")
100 type (inch), 2.5m	0.392m (15.4")	0.699m (27.5")	0.444m (17.5")	1.791m (70.5")	0.353m (13.9")	0.660m (26.0")	0.423m (16.6")	1.947m (76.6")

* Manufacturer's recommended size is 60 type (inch), 1.5m - 100 type (inch), 2.5m. • Tolerance ±8% (for projection distance a2)
• Final specifications may vary slightly.

■ Precision Control Wall Mount Unit*

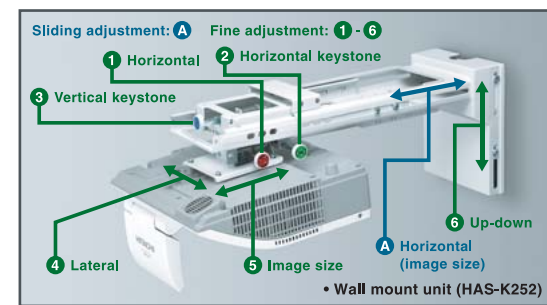

The wall mount unit ensures that the projector can be installed in exactly the right position. The entire unit slides horizontally, and fine adjustments can be made to each axis independently.

* Wall mount unit (HAS-K252): included with CP-AW252WNN/CP-A302WNN/CP-A222WNN.
Wall mount unit (HAS-K250): included with CP-AW2519NM.
Do not attempt to install the projector yourself. Have your dealer or service center handle all installation work.



Ultimate Short Throw LCD Projectors
CP-AW252WN/CP-AW252WNN
2,500 Lumens

WXGA

Ultimate Short Throw LCD Projectors
CP-A302WN/CP-A302WNN
3,000 Lumens

XGA

Ultimate Short Throw LCD Projectors
CP-A222WN/CP-A222WNN
2,200 Lumens

WXGA

Ultimate Interactive Short Throw LCD Projectors
CP-AW2519N/CP-AW2519NM
2,500 Lumens

• Wall mount unit (HAS-K252): included with CP-AW252WNN/CP-A302WNN/CP-A222WNN. Wall mount unit (HAS-K250): included with CP-AW2519NM.

ULTIMATE 究極 SHORT THROW

Advanced Network Functions*1

■ Wireless Capability (Option)*2

You can use a wireless network by connecting the projector to a computer using the optional USB wireless adapter. The adapter supports IEEE802.11b/g/n.



Wireless network functionality

Using the designated USB wireless adapter (option) enables the projector and computer to communicate in both the Ad-Hoc and Infrastructure modes.

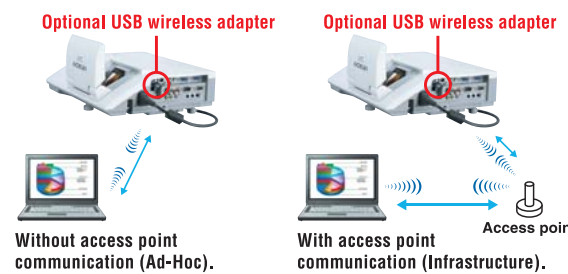

■ Messenger*3

The Messenger function transmits text data to the projector via a network, so the projector can display it. This is an easy and efficient way to send campus-wide announcements.

Messenger is ideal for:

- Campus Notifications • School Activities • Daily Schedules
- Community/Local News

* This function is not intended or guaranteed for the distribution of warning messages created by security systems.

■ Centralized Reporting

With just one computer in an administration room, you can collect reports from all projectors connected to the network.

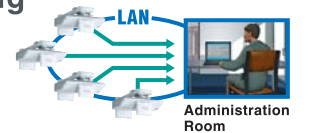

*1 Video transfer through network may not be supported depending on combination of computer hardware and software. For projecting video sources, video/computer cable is preferable.

*2 CP-AW252WN/CP-AW252WNN/CP-A302WN/CP-A302WNN/CP-A222WN/CP-A222WNN

*3 This function will be provided later by software updates from the website <http://www.hitachi-america.us/digitalmedia>

■ Network Presentations

You can project still or moving images from one or more networked computers. The Single PC mode lets you select one computer on the network, while the Multi PC mode lets you use up to four computers. Displaying various images from computers makes lessons and presentations much more effective.

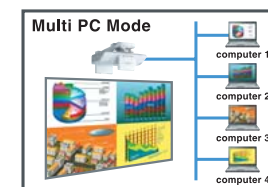

■ Hardware and software requirements for network capability

OS: One of the following. Windows® XP Home Edition/Professional Edition, Windows Vista® Home Basic/Home Premium/Business/Ultimate/Enterprise (Service Pack 1 or later), Windows® 7 Starter/Home Basic/Home Premium/Professional/Ultimate/Enterprise **CPU:** Pentium® 4 (2.8 GHz or higher) **Graphic card:** 16 bit, XGA or higher (When using the "LiveViewer" it is recommended that the display resolution of your computer be set to 1024 x 768.) **Memory:** 512 MB or higher **Hard disk space:** 100 MB or higher **Web browser:** Internet Explorer® 6.0 or higher **CD-ROM drive**

• If many computers are connected to the network or the connected computer is under excessive load, higher specifications may be required.

Wireless Pen Tablet for Hitachi Projectors* TB-1

The Wireless Pen Tablet gives you interactive functions such as the ability to write or draw over images from a compatible Hitachi projector. You do not need to install computer software so setup is quick and easy.

- No software installation necessary
- PC-less interactive functions
- Write or draw over images on screen
- Plug and Press (with supplied wireless adapter)
- Easy-to-use tool bar with 6 shortcut keys
- Projector control function

* Compatible projectors: CP-AW252WN/CP-AW252WNN/CP-A302WN/CP-A302WNN/CP-A222WN/CP-A222WNN.



Ultimate Short Throw and superior features let you upgrade the look of your business meetings



Superior Convenient Features

■ 4,000 : 1 High Contrast Ratio (Presentation Mode)*

* CP-AW252WN/CP-AW252WNN/CP-A302WN/CP-A302WNN/CP-A222WN/CP-A222WNN

■ WXGA (1280 x 800)* and 720p Capability

Featuring WXGA (1280 x 800) resolution, these projectors are capable of displaying wide and large images. * CP-AW252WN/CP-AW252WNN/CP-AW2519N/CP-AW2519NM

■ Approximately 3.8kg (8.4 lbs.)* Light Weight

Even with their many functions, these projectors are light, with a weight of only 3.8kg (8.4 lbs). * CP-AW252WN/CP-AW252WNN/CP-A302WN/CP-A302WNN/CP-A222WN/CP-A222WNN

■ 16W* Internal Speaker

The projectors have a built-in 16W speaker.

* CP-AW252WN/CP-AW252WNN/CP-A302WN/CP-A302WNN

■ Saver Mode Based on ImageCare® Technology*

The Saver mode reduces lamp power by 70% compared to the normal mode, resulting in considerable energy savings. You can set the time for the Saver mode from 1 to 30 minutes. If the projected image does not change by the set time, the Saver mode is activated, reducing lamp brightness and lowering power consumption. You can also enter the Saver mode manually by pressing the My button.

* CP-AW252WN/CP-AW252WNN/CP-A302WN/CP-A302WNN/CP-A222WN/CP-A222WNN

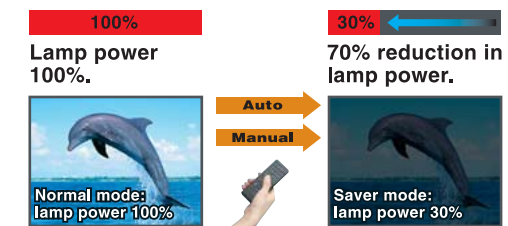

■ Cloning*

Projector settings can be transferred to other projectors via a USB memory stick. This makes it easy to use other projectors without having to take the time to configure the settings.

* CP-AW252WN/CP-AW252WNN/CP-A302WN/CP-A302WNN/CP-A222WN/CP-A222WNN

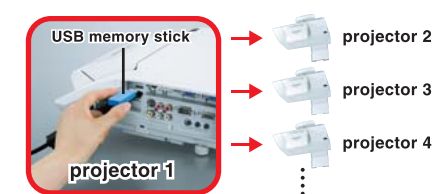

■ Perfect Fit

Perfect Fit enables quick adjustment of the projected image by moving its four corners one at a time. In addition, barrel or pincushion distortion, which occur on rounded surfaces, can easily be corrected.

* Perfect Fit may decrease picture quality as a result of the compensation and resizing processes.

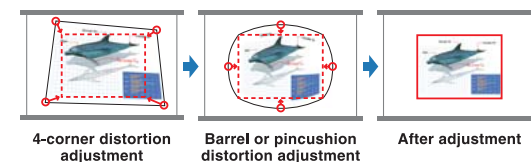

■ 3 LCD Panels with Inorganic Alignment Layers

These projectors incorporate three LCD panels with inorganic alignment layers that are extremely light resistant, increasing brightness and contrast ratio.

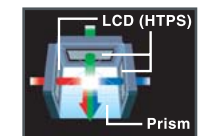

■ HDMI® Input

With signals transferred completely in the digital domain, lessons and presentations are assured of the highest image quality.



■ Easy Maintenance

The lamp door is on the top and the filter cover on the back, so maintenance and replacement of these parts can be done easily.

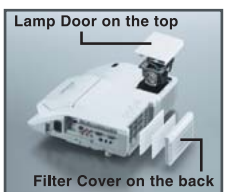

■ Hybrid Filter

The Hybrid Filter has an electrostatic design with hybrid protection filter layers, protecting the optics from dust, dirt and chalk particles. It also has a longer life than previous filters, so the projector requires less frequent maintenance.



■ Versatile Security Functions

The projectors are equipped with a security bar, PIN Lock, MyScreen Lock and Transition Detector functions.



■ More Convenient Features

- 2 USB Type A Inputs*1
- Low Noise of 28dB*2 (Eco Mode)
- MAC Address Label
- Display via USB
- Audio Pass Through*3
- Power Saving Mode
- Template Function*4
- Daytime Mode
- My Button
- My Memory
- Input Source Naming
- 4-Second Quick Start
- Direct Power On/Off
- Closed Caption
- Compatible with AMX Device Discovery
- Compatible with Crestron RoomView®*1

*1 CP-AW252WN/CP-AW252WNN/CP-A302WN/CP-A302WNN/CP-A222WN/CP-A222WNN

*2 Typical. Tested in 23°C environmental conditions.

*3 When in Normal mode at standby setting.

It does not function in Saving mode.

*4 Patent pending

Tabletop Use

The optional tabletop use kit (TT-251) allows the projector to be used vertically. You can project a 1.5m (60") image down onto a table.

Optional Tabletop Use Kit

Tabletop use kit (TT-251)

Fixing clamp

- Can be used for tables 25-50mm (1"-2") thick.

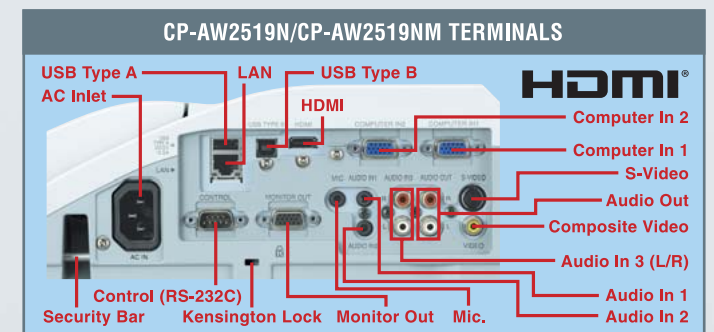
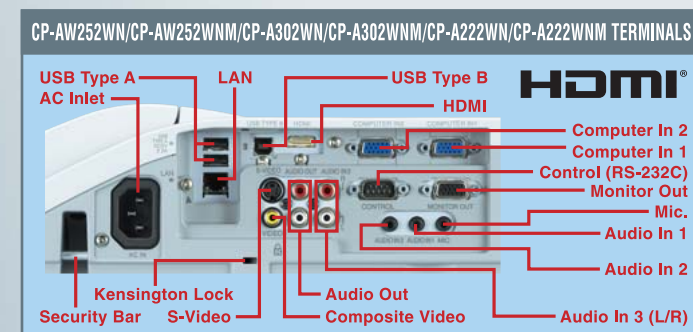

Projectors that previously only projected images now have interactive functions that surpass conventional uses

ULTIMATE 究極 SHORT THROW

Ultimate Interactive Short Throw LCD Projectors
CP-AW2519N/CP-AW2519NM

WXGA 2,500 Lumens

• Wall mount unit (HAS-K250): included with CP-AW2519NM.

StarBoard® Software Included.

• StarBoard® is a registered trademark of Hitachi Solutions, Ltd. in Japan and other countries.



Useful Interactive Functions for Education Use*

*All interactive functions require StarBoard Software.

Neatly Convert Letters or Figures with the StarBoard Software

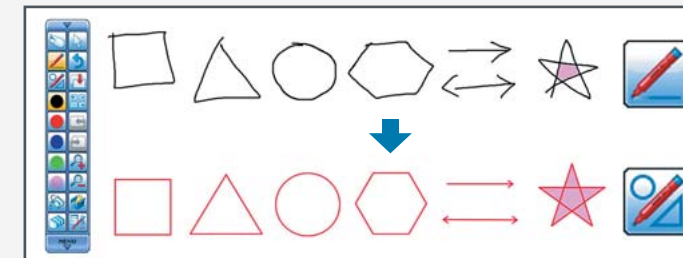

You can automatically convert freehand shapes into geometric objects and handwriting into text on the projected image using the StarBoard Software. These operations are easily accomplished with the interactive pen.

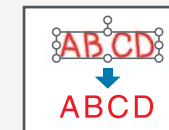

Subject Toolbox

There are four subject toolboxes: Geography, Language Arts, Math and Science. You can choose one from the toolbar for display on the screen, and use the various tools to hold the students' attention and improve their comprehension of the subject.

Language Arts: Anagrams

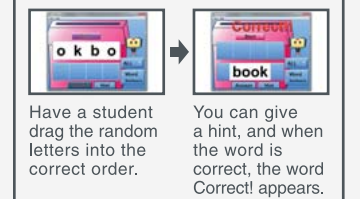

Have a student drag the random letters into the correct order.

You can give a hint, and when the word is correct, the word Correct! appears.

Select a Variety of Useful Tools

The interactive pen lets you operate a compass, ruler, protractor, stopwatch and other useful tools on the projected image using the StarBoard Software, making lessons even easier to understand.

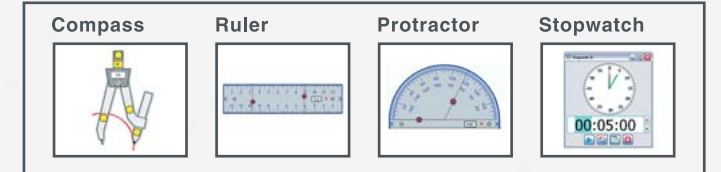

Screen Capture

In addition to Full Screen capture, you can also select Partial and Freehand capture.



Excellent Interactive Functions for Business Use*

*All interactive functions require StarBoard Software.

Meeting room walls become interactive spaces

With these projectors, as in the past you can write comments on a separate whiteboard while projecting images for effective meetings, and furthermore you can also write directly over the projected image on a wall using the StarBoard Software. What's more, the interactive function works on many types of surfaces: flat walls, whiteboards and even chalkboards.



Write Directly with the StarBoard Software

You can write letters or draw shapes directly on the image with the interactive pen using the StarBoard Software and of course use it to erase what you have added. You can erase or change pen color or thickness from the floating tool bar.

Interactive Pen

The interactive pen lets you select three mode variations. The Normal pen mode is best for annotations and freehand, Intelli-pen mode is best for writing notes and drawing shapes, and Pointer pen mode works like a laser pointer.

Operating a Mouse with the StarBoard Software

Using the supplied interactive pen as a mouse lets you perform computer operations on the projected image using the StarBoard Software.

Save Handwritten Data

You can save what you have written or drawn on the image using the StarBoard Software in PNG, JPEG, BMP, HTML or PDF formats. This is handy for retaining meeting notes, and for sharing them via email or printing them out.

Simple Calibration

Initial setup is faster and easier, because you can perform calibration just by touching nine locations with the supplied interactive pen.



You can use Microsoft® Word, Microsoft Excel® and Microsoft PowerPoint® with the StarBoard Software and Interactive Pen

Conference Mode

You can share the StarBoard Software whiteboard with people in remote locations.

Clip Art, Adobe® Flash® Learning Objects

The StarBoard Software includes clip art. You can drag 3D shapes and other images onto the page and then move, resize and rotate them. There are many interactive Adobe Flash files, which are useful for lessons. Math and science are already included in Clip Art.

Adobe Flash file: adding 1 digit numbers



Select a number and drag it into the box.

Click the pen on the answer box and the answer appears.

Adobe Flash file: adding decimal masses



Drag the animals onto the scale.

As each animal is added, the numbers on the scale change.

Windows®:

StarBoard Software Requirement Specifications

CPU: Intel® Pentium® 4 1.8GHz or faster **Free hard drive space:** 600 MB or more **RAM:** 1GB or more **Display colors:** 32 bits **Operating system (OS):** Windows XP 32bit/Windows Vista® 32bit/Windows 7 32/64bit (StarBoard Software has been tested with the latest service pack at release) (Tablet PC Edition and Server Edition are not supported) **Software required:** Internet Explorer® 7.0/8.0/9.0 (for using Internet search functions) Microsoft Word 2002/2003/2007/2010 (for viewing Word documents) Microsoft Excel 2002/2003/2007/2010 (for viewing Excel documents) Microsoft PowerPoint 2002/2003/2007/2010 (for viewing PowerPoint documents) Adobe Reader® 8.0/9.0/X (for viewing PDF documents) Adobe Flash Player 10 (for using Flash object) **Others:** DVD drive; Video card with hardware overlay feature (for using movie features)

For Webcam playback and capturing feature

• DV (Digital video, DV cameras, D-VHS, etc.) • Capture devices which support DirectShow (with WDM drivers)

For Conference host feature

CPU: Intel® Core™ 2 Duo 2.0GHz or faster **Free hard drive space:** 2GB or more **RAM:** 2GB or more **Others:** TCP/IP 54Mbps or above

For i-Learn: math toolbox

Display resolution: 1024 x 768 or higher **Software required:** Adobe Reader **Others:** 3D graphics card with 32-bit color

Macintosh®:

StarBoard Software Requirement Specifications

CPU: Intel CPU **Free hard drive space:** 600MB or more **RAM:** 1GB or more **Display colors:** High Color (16 bit) or higher **Operating system (OS):** Mac OS® X 10.5 / 10.6 / 10.7.2 **Software required:** Microsoft PowerPoint 2004/2008/2011 for Mac® (for viewing PowerPoint documents) Apple® QuickTime® 7.1 or above (for using movie features) Adobe Flash Player 10 (for using Flash object) **Others:** DVD drive

For Conference host feature

CPU: Intel Core 2 Duo 2.0GHz or faster **Free hard drive space:** 2GB or more **RAM:** 2GB or more **Others:** TCP/IP 54Mbps or above

For i-Learn: math toolbox

Display resolution: 1024 x 768 or higher **Software required:** Adobe Reader **Others:** 3D graphics card with 32-bit color

Recommended for efficient use of the CP-AW2519N/CP-AW2519NM interactive functions

CPU: Intel Core 2 Duo 2.0GHz or faster **Memory:** 1GB or more (Windows Vista or Windows 7: 2GB or more) **Free hard drive space:** 600MB or more **Display colors:** 32 bits **Web browser:** Internet Explorer 7.0/8.0/9.0 **Others:** For movie playback, hardware overlay is necessary for the video card. For web camera playback and capture, a DV capture device (digital video, DVD camera, etc.) that supports DirectShow with WDM device is necessary.

• Actual operating environment depends on the computer.

Recommended for efficient use of the CP-AW2519N/CP-AW2519NM interactive functions

CPU: Intel Core 2 Duo 2.0GHz or faster **Memory:** 2GB or more

• Actual operating environment depends on the computer.

Specifications

Model name		CP-AW252WN/CP-AW252WNM	CP-A302WN/CP-A302WNM	CP-A222WN/CP-A222WNM	CP-AW2519N/CP-AW2519NM
Liquid crystal panel		0.59 type (inch), 1.5cm polysilicon active-matrix TFT x 3	0.63 type (inch), 1.6cm polysilicon active-matrix TFT x 3		0.59 type (inch), 1.5cm polysilicon active-matrix TFT x 3
Number of pixels		1,024,000 pixels (H1280 x V800)	786,432 pixels (H1024 x V768)		1,024,000 pixels (H1280 x V800)
Resolution		1280 x 800 color pixels (WXGA)	1024 x 768 color pixels (XGA)		1280 x 800 color pixels (WXGA)
Digital zoom		x1.35			
Lamp		215W UHP			210W UHP
Light output (brightness)		2,500 Lumens	3,000 Lumens	2,200 Lumens	2,500 Lumens
Contrast ratio		4,000:1 (Presentation mode)			2,000:1 (Presentation mode)
Audio		16W			10W
Keystone correction		Manual Horizontal/Vertical Keystone			
Power supply		AC100-120V/AC220-240V			
Operating temperature		0-40°C/32-104°F			5-35°C/41-95°F (For interactive function: 16-35°C/61-95°F)*1
Input signals		Computer input: VGA, SVGA, XGA, WXGA, WXGA+, SXGA, WSXGA+, UXGA, MAC16*		VGA, SVGA, XGA, WXGA, WXGA+, SXGA, SXGA+, UXGA, MAC16*	
Video input		NTSC, NTSC4.43, PAL, SECAM, PAL-M, PAL-N, PAL (60Hz) 480i@60, 480p@60, 576i@50, 576p@50, 720p@50/60, 1080i@50/60, 1080p@50/60			
Input/output terminals		S-Video: mini DIN 4 pin x 1, Composite video: RCA x 1, Component video: via D-sub 15 pin mini x 2			
Video input x 3		Stereo mini x 2, RCA x 2 (L/R)			
Audio input x 3		Analog RGB: D-sub 15 pin mini x 2			
Computer input x 2		HDMI Connector x 1 (HDCP compliant)			
HDMI input x 1		RCA x 2 (L/R)			
Audio output x 1		Analog RGB: D-sub 15 pin mini x 1			
Monitor output x 1		USB type A x 2 (for PC-less presentation or wireless adapter), USB type B x 1 (for USB display or USB mouse control)			
USB		USB type A x 1 (for PC-less presentation), USB type B x 1 (for USB display or USB mouse control, and interactive function)			
Control		D-sub 9 pin x 1 for RS232C			
Wireless network		Option with USB wireless adapter (USB-WL-11N)			
Wired network (LAN)		RJ45 x 1			
Mic. input		Mono mini x 1 (compatible with dynamic microphones and unbalanced signal lines)			
Agency certifications		UL/cUL, FCC Part15 class B, AS/NZS CISPR22 class B, CE, RoHS, GOST-R			UL/cUL, FCC Part15 class A, AS/NZS CISPR22 class A, CE, RoHS, GOST-R
Dimensions (WxHxD)		345 x 85 x 303mm (13.6" x 3.3" x 11.9") [excluding protruding part, when mirror is closed.]			345 x 102 x 303mm (13.6" x 4.0" x 11.9") [excluding protruding part, when mirror is closed.]
Weight		Approximately 3.8kg (8.4 lbs.)			Approximately 4.1kg (9.0 lbs.)
Standard accessories*2		Remote control (Part#: HL02882) with two AA batteries, Power cord, Computer cable, Cable cover, User's manuals, Security label, Application CD, Wall mount unit (HAS-K252) and user's manual*3, Adapter cover			Remote control (Part#: HL02772) with two AA batteries, Power cord, Computer cable, USB cable, Interactive Pen*4, two AAA batteries and the tip of the pen for exchange, Cable cover, User's manuals, Security label, Software applications (CD x 1, DVD x 1), Wall mount unit (HAS-K250) and user's manual*5, Sensor cover
Optional accessories		Lamp: DT01381, Filter set: UX37191, Laser remote control: HL02651 (RC-R008), Tabletop use kit: TT-251, USB wireless adapter: USB-WL-11N			Lamp: DT01251, Filter set: UX37191, Laser remote control: HL02651 (RC-R008), Tabletop use kit: TT-251

*1 If the mouse cursor or drawing image does not match the actual pen tip point perfectly, please calibrate again to optimize the interactive system.

*2 Standard accessories, like power cord, vary across regions or countries.

*3 Optional with CP-AW252WN/CP-A302WN/CP-A222WN

*4 Depending on surface textures of screens or walls, etc. where images are projected, abrasion of the interactive pen tip may be accelerated, resulting in the need for pen tip exchange.

*5 Optional with CP-AW2519N

Supplied Cable Cover and Wall Mount Unit

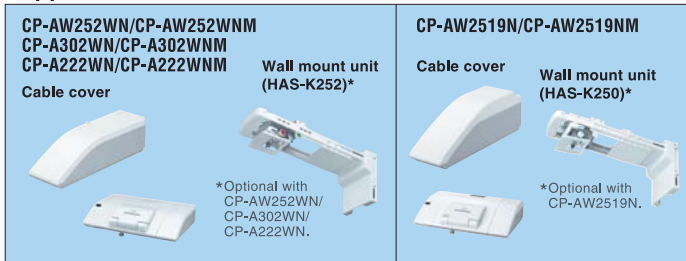

Dimensions

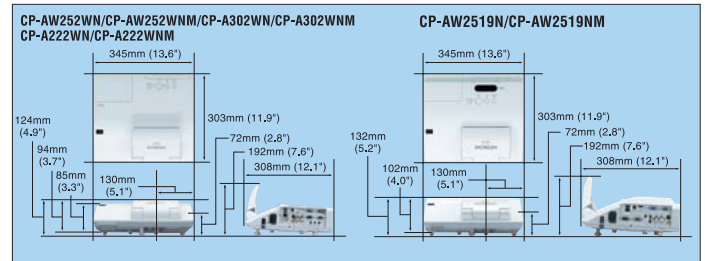

Consideration for the Environment

Compliance with EU Directive RoHS*1

*1 RoHS is the acronym of "DIRECTIVE 2002/95/EC OF THE EUROPEAN PARLIAMENT AND OF THE COUNCIL OF 27 January 2003 on the restriction of the use of certain hazardous substances in electrical and electronic equipment".

Reduction of resin usage in production

Use of hot runners in molds for making upper housing in order to reduce mill ends.

Reduction of CO2 emissions

Carton volume has been cut down to 60% (CP-AW2519N)/40% (CP-AW252WN/CP-A302WN/CP-A222WN)*2, reducing CO2 emissions during transport.

*2 Compared to Hitachi CP-A100 ultra-short throw projector on the basis of one carton box.

Power saving mode engaged during standby

Eco mode

Eco mode provides power saving.

Design and specifications are subject to change without notice.

- The projected images and comparison photos in this catalog are simulations.
- LCD panels, polarizers and other optical components and cooling fans may need replacement after prolonged usage. For more details, please consult a Hitachi sales representative.
- Do not use in places where there is a lot of water, dampness, steam, dust, soot or tobacco smoke. This may result in fire or malfunction.
- Optical components (lamp, LCD panel, polarizing plate, PBS [polarizer beam splitter]) have limited service lives. They must be repaired or replaced if they are used for a long period of time.
- These projectors use a mercury lamp with high internal pressure. Because of its properties, this lamp may burst with a loud noise or burn out if struck or after it has been used for a period of time. The time until it bursts or burns out varies greatly according to differences between lamps and usage conditions. Turning the lamp's power on and off frequently shortens its service life.
- Optical components other than the lamp: If the projector is used for six hours or more per day, they may need to be replaced in less than a year.
- LCD panel: If the projector is used continuously for six hours or more, its replacement cycle may be shortened.
- Do not turn projector on again for ten minutes after shutdown. Neglect can shorten the lifetime of the lamp. During use and immediately after use, do not touch anywhere near the lamp and the vents as these parts are extremely hot.
- Microsoft®, Excel®, PowerPoint®, Windows®, Windows Vista® and Internet Explorer® are trademarks, or registered trademarks of Microsoft Corporation in the United States and/or other countries.
- Intel®, Pentium®, and Intel® Core™ are trademarks of Intel Corporation in the U.S. and/or other countries.
- Adobe®, Acrobat®, Flash® and Reader® are registered trademarks or trademarks of Adobe Systems Incorporated in the United States and/or other countries.
- Apple®, Macintosh®, Mac OS®, Mac® and QuickTime® are registered trademarks of Apple Inc.
- Crestron® and Crestron RoomView® are registered trademarks of Crestron Electronics, Inc. in the United States and other countries.
- ImageCare is a trademark or a registered trademark of Royal Philips Electronics in the United States and other countries.
- HDMI, the HDMI Logo, and High-Definition Multimedia Interface are trademarks or registered trademarks of HDMI Licensing LLC in the United States and other countries.
- eBeam, the eBeam logo and eBeam Enabled are trademarks or registered trademarks of Luidia, Inc.
- All other trademarks are the properties of their respective owners.

Remote control warning: Do not look into the laser beam. Class 2 Laser product; maximum output 1mW; wavelength 650nm.

HITACHI

Hitachi America, Ltd. Business Solutions Group 900 Hitachi Way, Chula Vista, CA 91914-3556, U.S.A. and Canada Tel: +1-800-448-2244 www.hitachi-america.us/projectors
 Hitachi Home Electronics Asia (S) Pte. Ltd. 438A Alexandra Road #01-01/02/03, Alexandra Technopark, 119967, Singapore Tel: +65-6536-2520 www.hitachiconsumer.com.sg
 Hitachi Sales (Malaysia) Sdn. Bhd. Lot 12, Jalan Kemajuan, Bangi Industrial Estate, 43650 Bandar Baru Bangi, Selangor Darul Ehsan, Malaysia
 Tel: +60-3-8911-2670 www.hitachiconsumer.com.my
 Hitachi Sales (Thailand), Ltd. 994, 996 Soi Thonglor, Sukhumvit 55 Road, Klongtonna, Vadhana Bangkok 10110, Thailand Tel: +66-2381-8381-98 www.hitachi-th.com
 Hitachi (Hong Kong), Ltd. 18th Floor, Ever Gain Centre, 28 On Muk Street, Shatin, N.T., Hong Kong Tel: +852-2113-8883 www.hitachi-hk.com.hk
 Hitachi Sales Corp. of Taiwan 2nd Floor, No.65, Nanking East Road, Section 3, Taipei 104, Taiwan Tel: +886-2-2516-0500 www.hsct.com.tw
 Hitachi Australia Pty Ltd. Suite 801, Level 8, 123 Epping Road, North Ryde NSW 2113, Australia Tel: +61-2-9888-4100 www.hitachi.com.au
 Hitachi Europe Ltd., Digital Media Group Consumer Affairs Department Whitebrook Park, Lower Cookham Road, Maidenhead, Berkshire, SL6 8YA, UK
 Tel: +44-1628-585000 www.hitachidigitalmedia.com



• ImageCare® is applicable to CP-AW252WN/CP-AW252WNM, CP-A302WN/CP-A302WNM and CP-A222WN/CP-A222WNM.